



► Kullanım Alanları



Otel



Restaurant



Hızlı Yemek



Kokteyl



Disko



Endüstri



► Teknik Özellikler

Buz Yapma Kapasitesi	57 kg/57 kg	Ürün Yüzey Kalitesi	AISI 304 SS Fırçalı
Buz Stoklama Kapasitesi	28 kg	Soğutma Sistemi	Hava
Bir Çevrimdeki Buz Adedi	44 Adet	Ürün Ölçüleri (e*b*y)	500*580*800
Soğutucu Gaz	R134a-R404a/R290	Ambalaj Ölçüleri (e*b*y)	555*635*965
Akım	10 A	Brüt Ağırlık	48 kg
Maksimum Güç	600 W/550 W	Yükleme Miktarı (20 HC)	72 Adet
Günlük Elektrik Tüketimi	14,9 kW/14,7 kW	Yükleme Miktarı (40 HC)	144 Adet
Voltaj	230V-50/60Hz/230V-50Hz	Yükleme Miktarı (TIR)	186 Adet
	115V-60 Hz		

► Üstün Özellikler



Püskürtmeli Sistem



Poliüretan İç Kabin



Hava Soğutmalı



Kolay Temizlik



Elektronik Kontrol

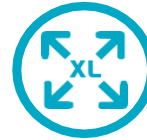

Geniş Buz Saklama Alanı



Tropikal İklim Sınıfı



Antibakteriyel İç Gövde



Manyetik Pompa



El tutamıklı kapı



Temizlenen Hava Filtresi



Fonksiyonel Düğme



Drenajlı Servis Kiti



Kolay Erişim



Raylı Kapı



Opsiyonel Potansiyometre

► Buz Şekilleri



18 gr/adet

► Sertifikalar





► Ürün Ölçüleri

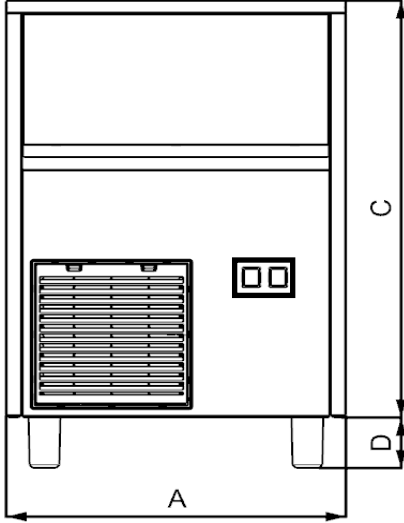
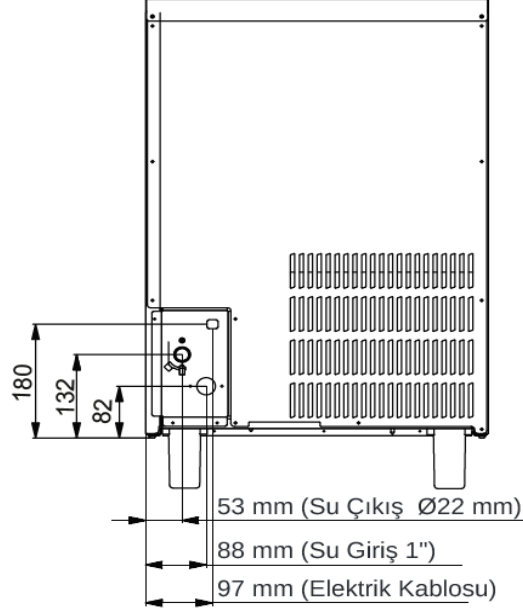
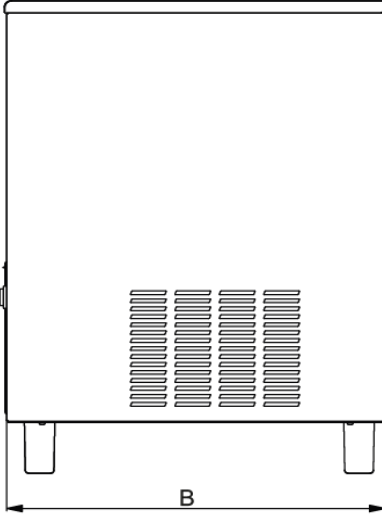

Model	A (mm)	B (mm)	C (mm)	D (mm)	Ağırlık
FR25	355	435	590	D2	26 kg
FR30	390	515	640	D1	32 kg
FR35	500	580	690	D1	38 kg
FR40	500	580	690	D1-D2	40 kg
FR50	500	580	800	D1-D2	45 kg
FR60	500	580	800	D1-D2	48 kg
FR70	738	600	822	D1-D2	75 kg
FR90	738	600	822	D1-D2	85 kg

Opsiyon	D (mm)	
Standart Ayarlanabilir Ayak	D1	78,5
Kısa Ayarlanabilir Ayak	D2	10

► Limitler

- Su Giriş 1"
- Su Çıkış 22 mm
- Su Basıncı Min. 1 Bar / Mak. 5 Bar

Bütün teknik bilgiler aşağıda yer alan durumlara göre hazırlanmıştır.

Ortam Sıcaklığı :20°C

Su Sıcaklığı :15°C

Elektrik Tüketimi :+32 °C (Standart Voltaj)

Şirket, model ve özelliklerini bilgilendirme yapmadan değiştirme hakkını saklı tutar

► Buz Üretim Kapasitesi

R134a-R404a

Hava Sic. °C	Su Sıcaklığı °C			
	10°	15°	21°	32°
10°	100%	98%	95%	93%
21°	98%	96%	90%	87%
32°	90%	87%	80%	78%
38°	80%	75%	70%	60%

R290

Hava Sic. °C	Su Sıcaklığı °C			
	10°	15°	21°	32°
10°	100%	98%	95%	93%
21°	98%	96%	90%	87%
32°	90%	87%	80%	78%
38°	80%	75%	70%	60%

